

TOP VIEW

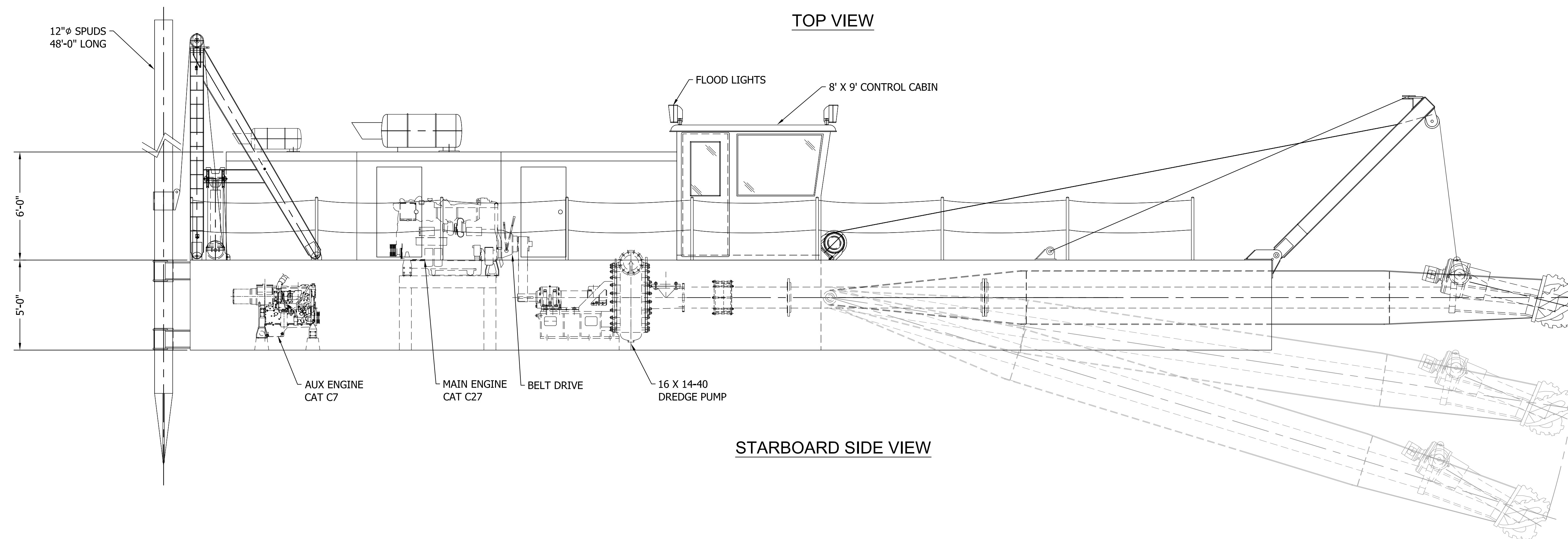

STARBOARD SIDE VIEW

NOTE:
 DIGGING DEPTH @ 45° : 30'-0"
 DIGGING DEPTH @ 60° : 36'-0"
 EST. PROD. RANGE : 318-530 YD³/HR (15-25% SOLIDS BY VOLUME)

REVISIONS		
Date	Description	Approved

PRELIMINARY FABRICATION AS-BUILT

PIONEER DREDGE MODEL LINE-UP

PREDATOR 2000-14
 GENERAL ARRANGEMENT



8515 Baymeadows Way, Suite 201
 Jacksonville, Florida 32256 USA
 sales@pioneerdredge.com

Phone +1-904-503-9776 Fax +1-904-732-2152

DRAWN: EJL	
CHECKED:	
DATE: 9-3-2013	WEIGHT:
JOB NO.	REV. 0
DWG NO. 14-2000-001	